

## Illustra Standard E Series Bullet Camera Quick Start Guide

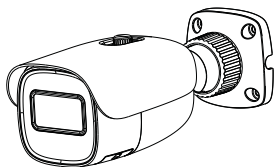

- Please read this instruction carefully before operating the unit and keep it for further reference.
- All the examples and pictures used here are for reference only.
- The contents of this manual are subject to change without notice.

### 1 Warning and Caution

- If the product does not work properly, please contact your dealer or the nearest service center. Never attempt to disassemble the camera yourself. (We shall not be responsible for any problems caused by unauthorized repair or maintenance.)
- In the use of the product, you must be strict compliance with the electrical safety regulations of the nation and region. When the product is mounted on wall or ceiling, the device shall be firmly fixed.
- Do not allow water or liquid intrusion into the camera.
- Do not use camera beyond specified voltage range.
- Do not drop the camera or subject it to physical shock.
- Avoid touching the camera lens.
- If cleaning is necessary, please use clean cloth to wipe it gently.
- Do not aim the camera at the sun or extra bright place.
- Do not place the camera in extremely hot, cold (the operating temperature shall be  $-30^{\circ}\text{C}\sim 60^{\circ}\text{C}$ ), dusty or damp locations, and do not expose it to high electromagnetic radiation.
- To avoid heat accumulation, good ventilation is required for operating environment.

### 2 Package

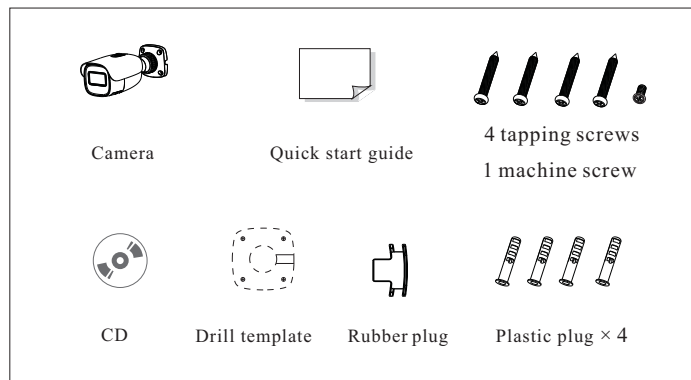

### 3 Overview

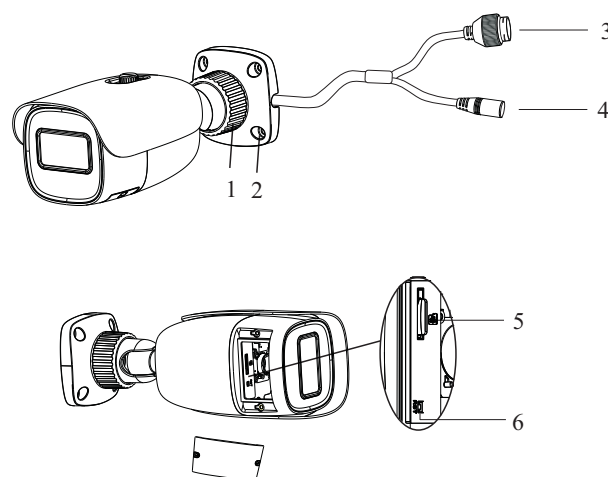

- |                      |                      |
|----------------------|----------------------|
| 1 Fixed ring         | 4 Power connector*   |
| 2 Mounting base      | 5 Micro SD card slot |
| 3 Network connector* | 6 Reset              |

- \* It is recommended to install the security cap for outdoor installation.
- \* If the PoE switch is used to power the camera, DC12V power supply is not required.

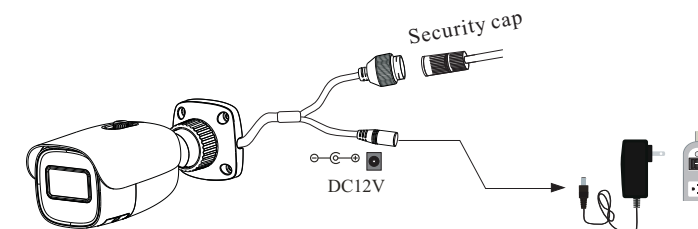

### Connecting Network Cable

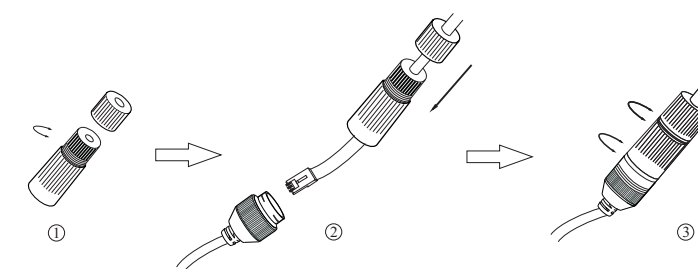

- ① Loosen the nut from the main element.
- ② Run the network cable (without RJ 45 connector) through the both elements. Then crimp the cable with RJ 45 connector.
- ③ Connect the cable to the hermetic connector. Then tighten the nut and the main cover.

### 4 Installation

Please make sure that the wall or ceiling is strong enough to withstand 3 times the weight of the camera. Please install the camera under dry environment.

- ① Drill the screw holes and the cable hole on the wall according to the drill template.

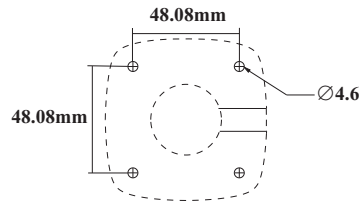

- ② Route and connect the cables .
- ③ Secure the mounting base with camera to the wall with the screws provided.

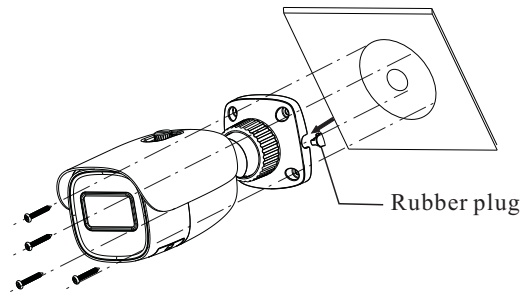

- ④ Bracket adjustment. Before adjustment, preview the image of the camera on a monitor and then loosen the fixed ring to adjust the view angle of the camera.

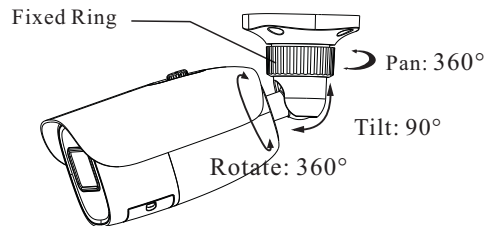

## 5 Network Connection

### ● Access the camera through TycoIPTool

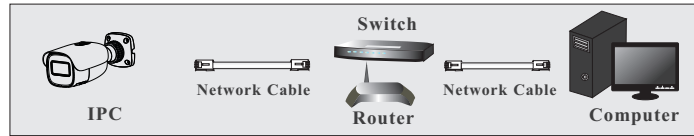

- ① Make sure that the camera and the PC are well connected to the LAN.
- ② Find the TycoIPTool from the CD and then install it in the computer. After that, run the TycoIPTool as shown below.

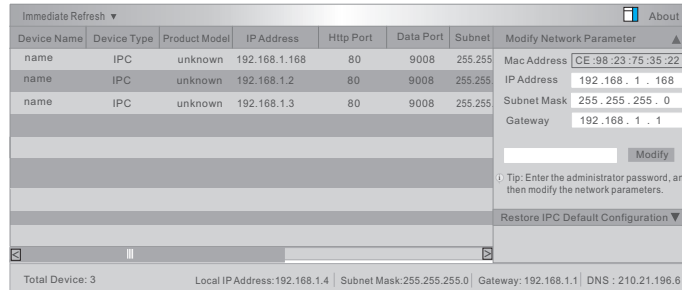

- ③ Modify the IP address. The default IP address of this camera is 192.168.1.168. Click the information of the camera listed in the above table to show the network information on the right hand. Modify the IP address and gateway of the camera and make sure its network address is in the same local network segment as that of the computer. Please modify the IP address of your device according to the practical situation.

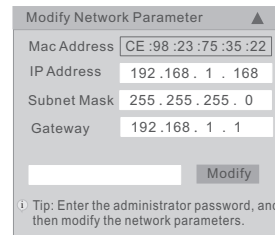

For example, the IP address of your computer is 192.168.1.4. So the IP address of the camera shall be changed to 192.168.1.X and the gateway shall be changed to 192.168.1.1. After modification, please enter the password of the administrator and click “Modify” button to modify the settings.

⚠ The default password of the administrator is “*admin*”.

- ④ Double-click the camera listed in the IP-Tool or manually enter the IP address in the address bar of the web browser to connect IP-CAM. Then follow directions to download and install the plugin.
- ⑤ Enter the username and password in the login interface.

⚠ The default username is *admin*; the default password is *admin*.

Available Models:

ISE-B05F363S-N	ISE-B05F364-N	ISE-B04V013S-N	ISL-B04M013-N
ISE-B05F063S-N	ISE-B05F064-N	ISE-B04V014S-N	ISL-B04V013-N
ISE-B04F363S-N	ISE-B04F364-N	ISE-B04M013S-N	
ISE-B04F063S-N	ISE-B04F284-N	ISE-B04M014S-N	